

REVISION RECORD				
REV	ECD	DESCRIPTION	DRFT	CHKD

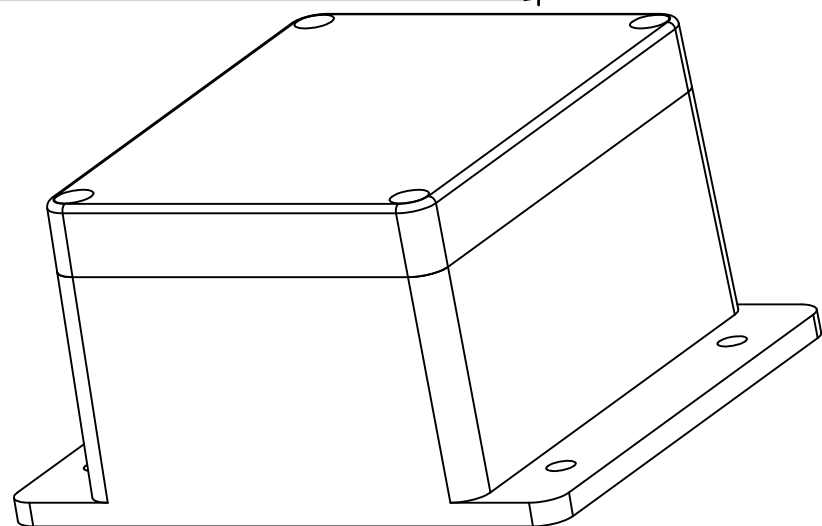
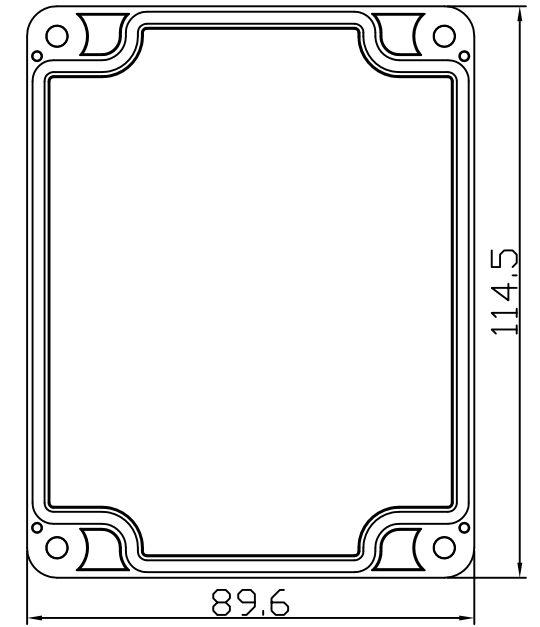
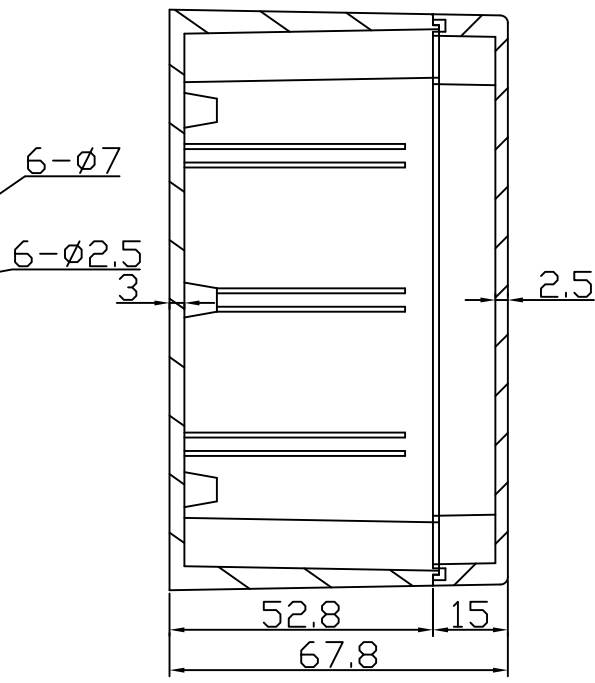
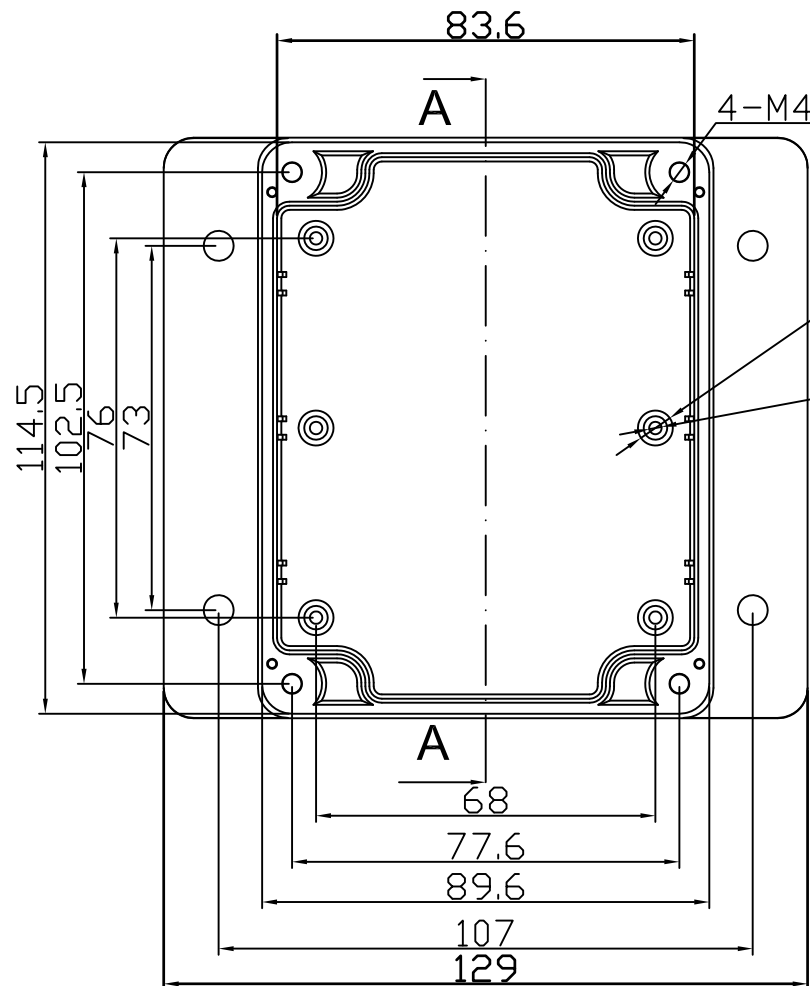

A-A

DETACHED LISTS			DRAWN	NAME	DATE		<b>EVEREST</b> WWW.EVERESTCASE.COM	
	TOLERANCES EXCEPT AS NOTED		CHECKED	Kelvin	01/20/2015			
	MM		ENG APPR.				TITLE	
	.0 ± 0.3	±	MATERIAL : ABS		PW026		DRAWING NO. PW026	SIZE
.00 ± 0.2	±	QT'Y :		/PART NO. 00		A4	REV	
.000 ± 0.1	±	FINISH:		DO NOT SCALE DRAWING		SHEET 1	OF 1	
ANGLES ± 5°		SCALE : 1:1						
		FIRST ANGLE PROJECTION						