

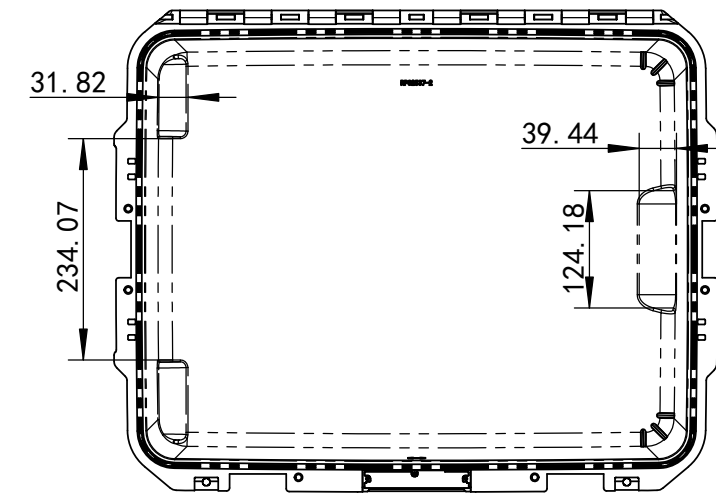

| | | | | | | | | | | |
|----------------|-------|-------|-------|--------|--------|--------|--------|---------|----------|----------|
| BASIC SIZE | 0~3 | >3~6 | >6~10 | >10~18 | >18~30 | >30~50 | >50~80 | >80~120 | >120~180 | >180~250 |
| DIMS TOLERANCE | ±0.14 | ±0.18 | ±0.22 | ±0.27 | ±0.33 | ±0.39 | ±0.46 | ±0.54 | ±0.63 | ±0.72 |

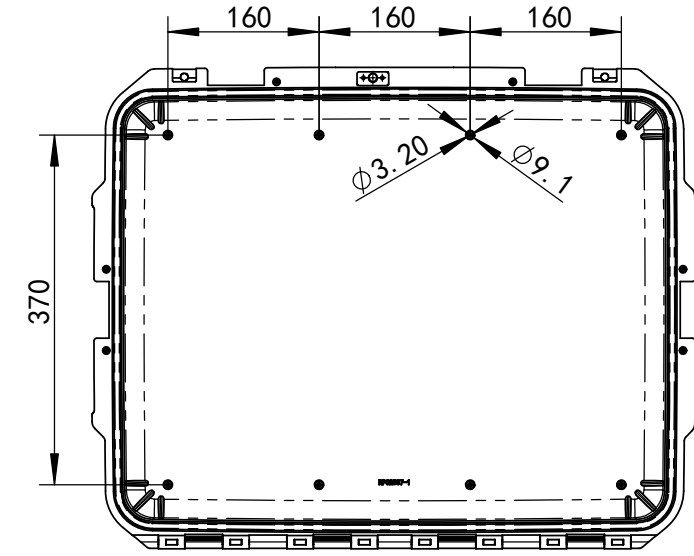
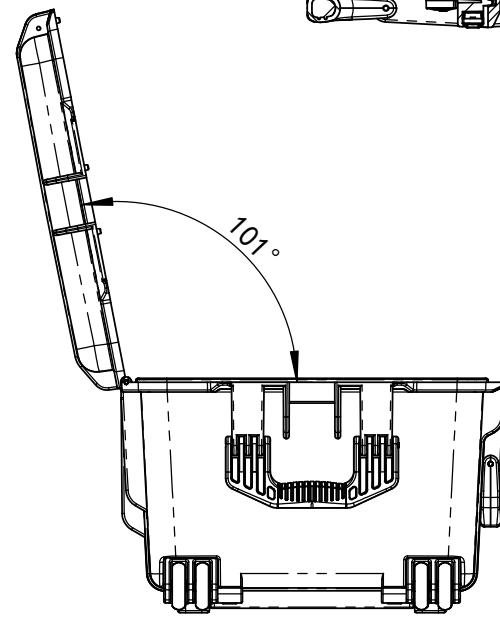
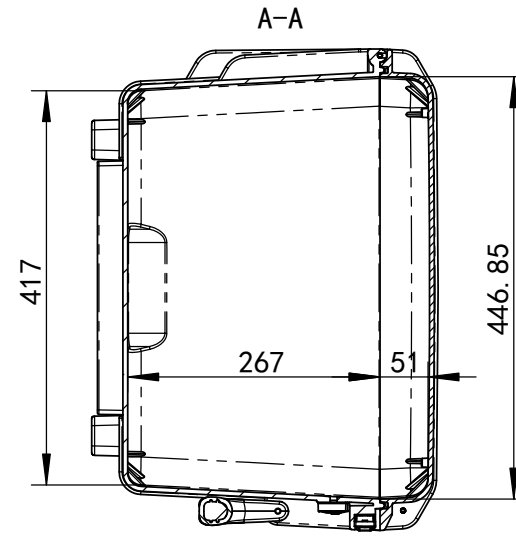
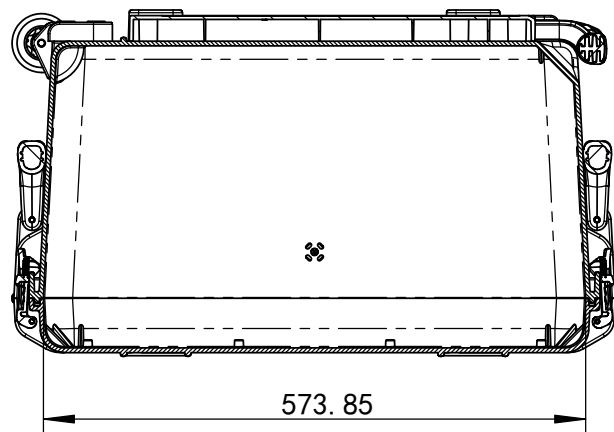
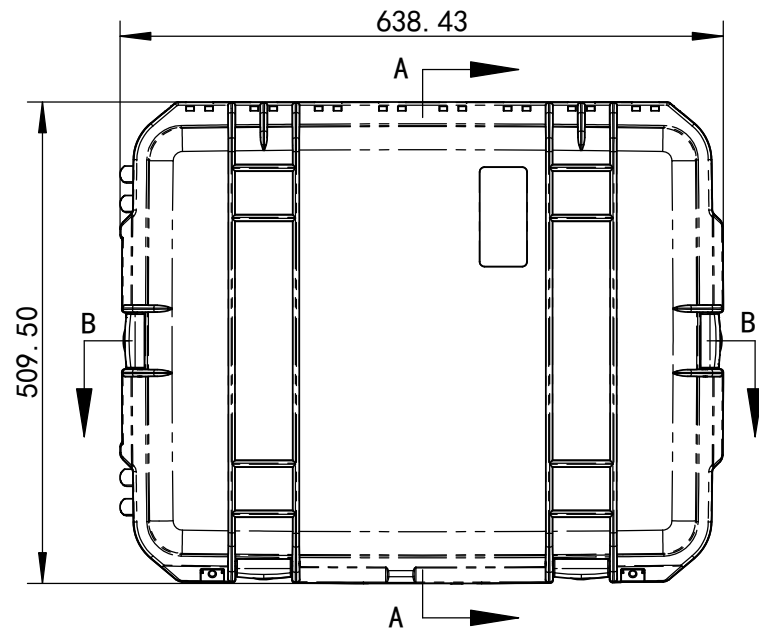
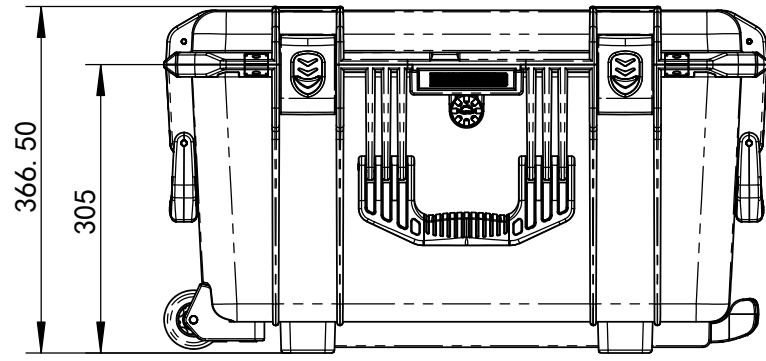
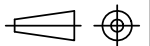

| | | | | | | |
|---|---|----------|-----------|---|----------------------|-------------|
| THE MACHINING TOLERANCES | | NAME | DATE |  DRX.EVEREST WWW.EVERESTCASE.COM | | |
| UNSPECIFIED TOLERANCES FOLLOW GB/1804-1992 IT13 | | DRAWN | 2017/8/23 | | | |
| FOAM TOLERANCES | ±3mm | CHECKED | | TITLE | RHINO CASE | |
| THE ANGLE TOLERANCES | ±1° | ENG APPR | | MATERIAL | PP | |
| FIRST ANGLE PROJECTION |  | QT'Y : 1 | | PART NO | RPC2537 | |
| | SCALE | 1:1 | UNIT | mm | DO NOT SCALE DRAWING | SHEET OF1 2 |